

Data Sheet



Article number: 20100008A

Description: E+G

Side thrust pin GN 714-10-40

Measures

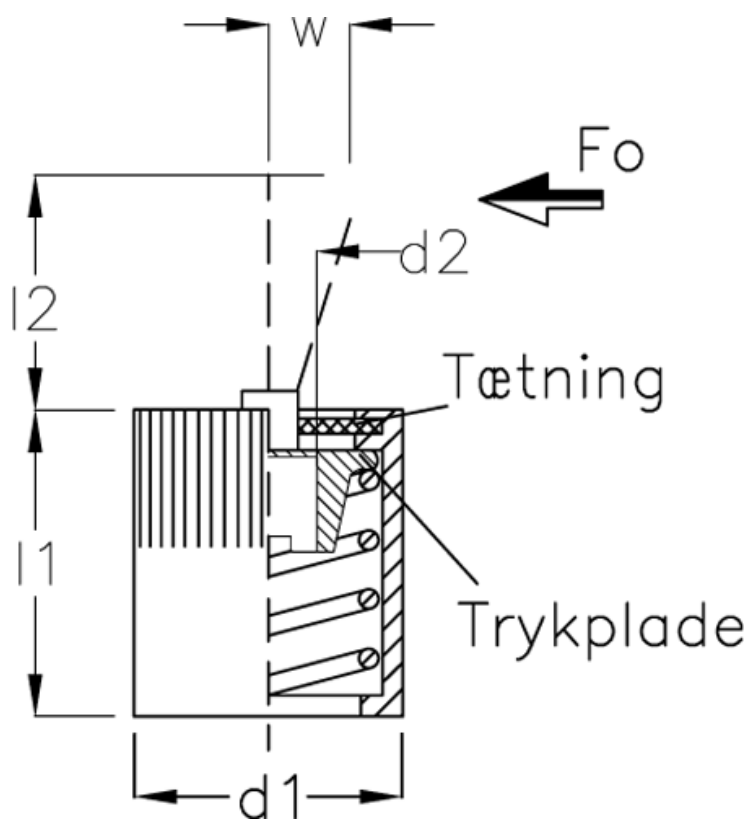

d1	= 10
d2	= M4
d3	= 10
H	= 12
l1	= 12
l2	= 7.5
screw driver	= GN 715.1-5
Side power N at l2	= 40

W = 2.0